

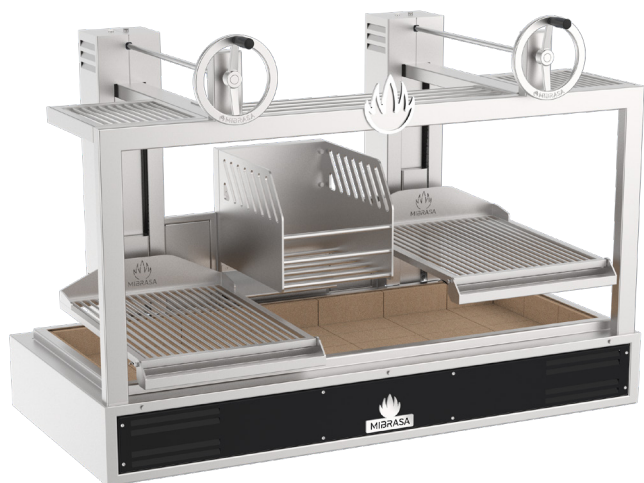

# FIRE 160

Mibrasa® Parrilla with two grills and fire basket



## FEATURES

Precision and strength is key to the PARRILLA MIBRASA®. Effortlessly regulate the height of your grill surface thanks to the carefully engineered double chain system coupled with the crank wheel and gearbox, keeping maintenance down to a minimum.

ERGONOMICALLY DESIGNED WITH MAXIMUM QUALITY AND SECURITY

With a sloping grill, the grease runs down the weld-free grill bars to prevent grease build-up. Grease drips down to the collector with an easy to remove mechanism ready to clean.

The base is lined with refractory bricks to ensure maximum heat efficiency and resistance to pure fire. And the built-in cooling system in outer case guarantees a maximum level of security.

Built using quality steels providing strength and durability; ergonomically designed for practicality and ease of use, each feature plays a crucial part in delivering the ultimate grilling machine for every chef.

## TECHNICAL INFORMATION

Reference	GMB 160-FIRE
Fire up time*	30 min
Cooking temperature	250 °C
Grill height range	350 mm
Initial charcoal load <sup>1</sup>	12 kg
Charcoal load duration <sup>2</sup>	5 h
Equivalent power*	5.2 kW
Exhaust rate	4600 m <sup>3</sup> /h
Net weight <sup>3</sup>	420 kg
Crated weight <sup>3</sup>	550 kg
Crate dimensions (WxDxH)	1120 x 1810 x 1380 mm

\*Approximate data

1. Consult instruction manual

2. Will vary depending on quality of charcoal

3. Weight with accessories included

## INCLUDED ACCESSORIES

- Mibrasa tongs [TG]
- Ash shovel [PALA]
- Ember poker [PK]
- Grill brush [CEP]
- 2 rod grills [CPV-160F]
- Vertical cooking rack [CPH-160-FIRE]
- 2 swivel hooks [GGCV]

## OPTIONAL ACCESSORIES

- V-shape grill [GV-160F]
- End of service lid [TAPA65]
- Protective structure [EPGMB160F]
- Espeto kit [KITESPGMB160]
- Gastronorm kit [SGN160]

### Color



### Edition



## QUALITY GUARANTEE



Front view

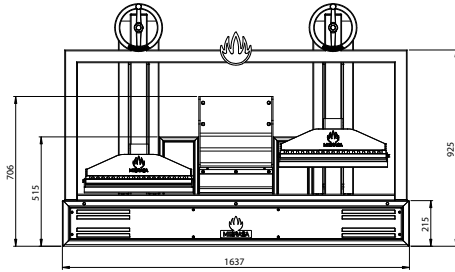

Top view

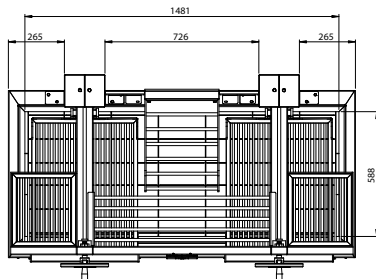

Dimensions in mm

Side view

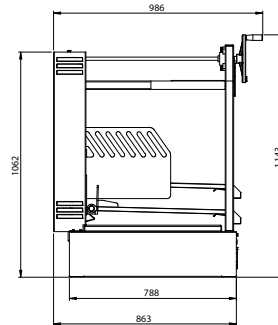

Fire basket

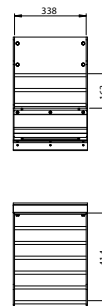

## GRILL TYPES

Rod bar grill

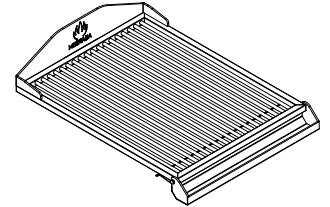

V shape grill

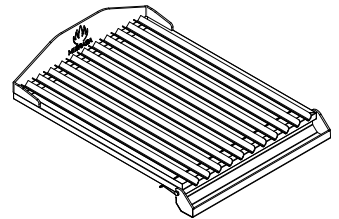

## GRILL DIMENSIONS

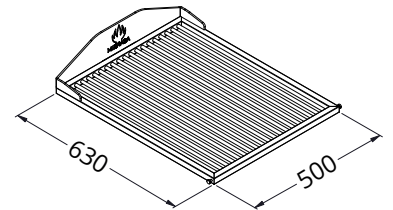

## HEATING RACK DIMENSION

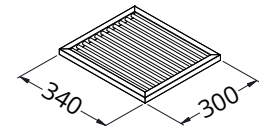

## OPTIONAL LID DIMENSION

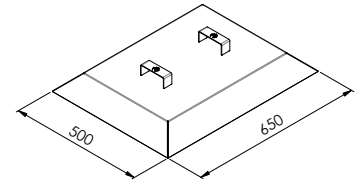

## VERTICAL COOKING RACK DIMENSIONS

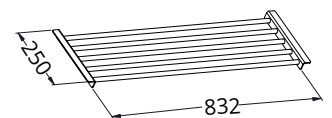

Specifications and design are subject to change without notice.

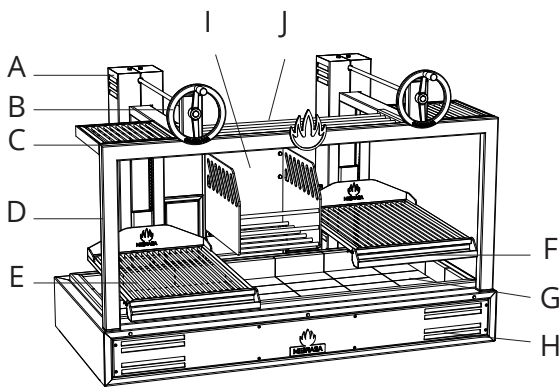

A	Elevating system
B	Elevating wheel
C	Heating rack
D	Structure
E	Grill
F	Grease collector
G	Refractory bricks
H	Main body
I	Fire basket
J	Vertical cooking rack

## INSTALLATION GUIDELINES AND SAFETY STANDARDS

Recommended installation height	700 mm
Clearances to construction/other appliances from the Parrilla	76 mm
Clearances of flammable materials from the Parrilla	300 mm
Clearance of workspace from front of the Parrilla	700 mm



It is recommended to use a lifting device to lift the Parrilla and place on the countertop/stand. Consult Parrilla instruction manual for further information.

## OPTIONAL COMPLETE STAND



Dimensions in mm

## TECHNICAL INFORMATION

Ref.	GMB160-FIRE + MCGMB160
Net weight <sup>3</sup>	530 kg
Crated weight <sup>3</sup>	660 kg
Crate dimensions (WxDxH)	1120 x 1510 x 2000mm

Ref.	MCGMB160
Net weight <sup>3</sup>	110 kg
Crated weight <sup>3</sup>	125 kg
Crate dimensions (WxDxH)	1120 x 1510 x 700mm

## OPTIONAL ACCESSORIES

- Stainless steel casters [WINOXG]

FRONT VIEW

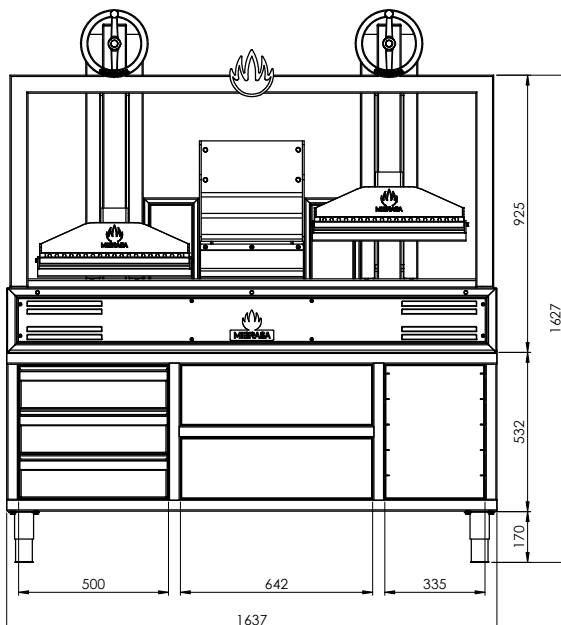

SIDE VIEW

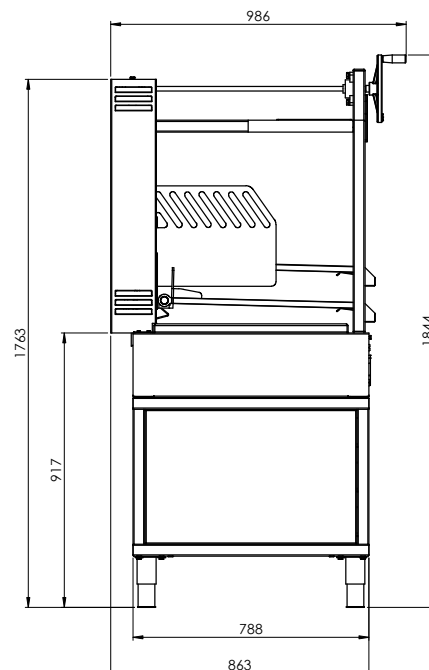

\*Adjustable leg height 135-195 mm

## OPTIONAL STAND



Dimensions in mm

## TECHNICAL INFORMATION

Ref.	GMB160-FIRE + MAGMB160
Net weight <sup>3</sup>	480 kg
Crated weight <sup>3</sup>	610 kg
Crate dimensions (WxDxH)	1120 x 1510 x 2000 mm

Ref.	MAGMB160
Net weight <sup>3</sup>	60 kg
Crated weight <sup>3</sup>	75 kg
Crate dimensions (WxDxH)	1120 x 1510 x 700 mm

## OPTIONAL ACCESSORIES

- Stainless steel casters [WINOXG]

FRONT VIEW

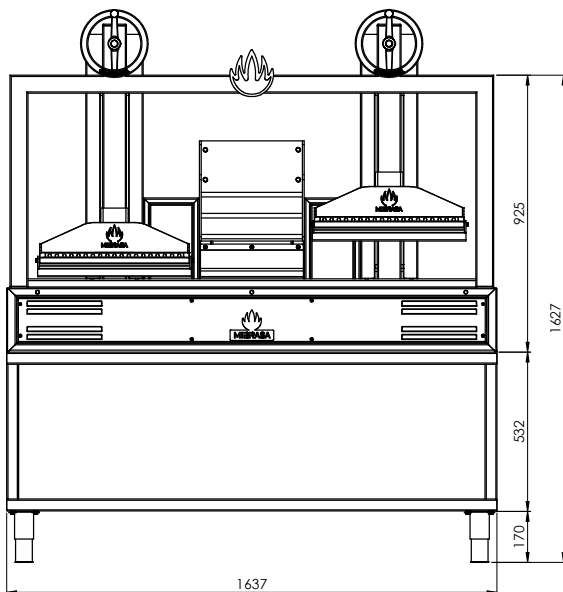

SIDE VIEW

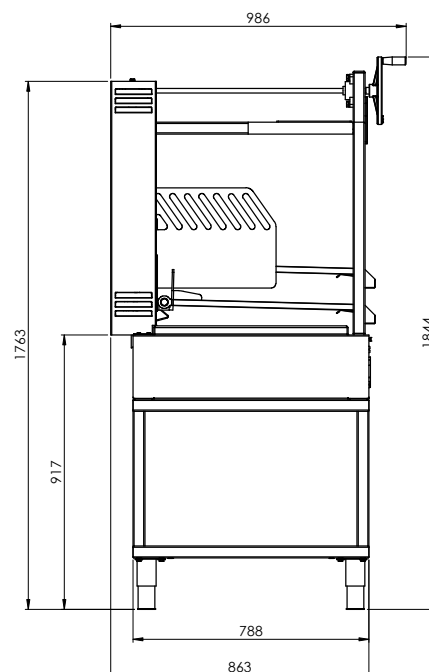

\*Adjustable leg height 135-195 mm